

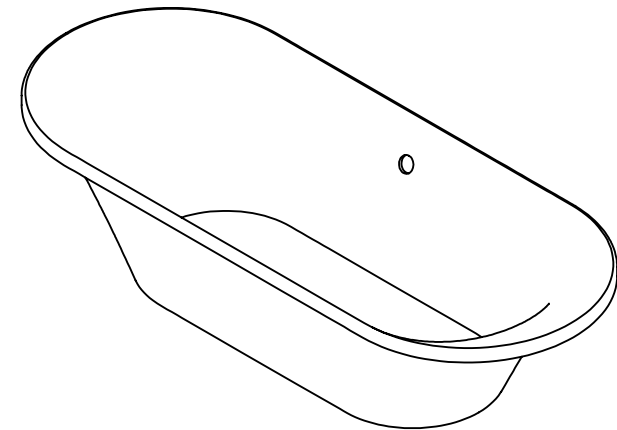

SECTION A-A

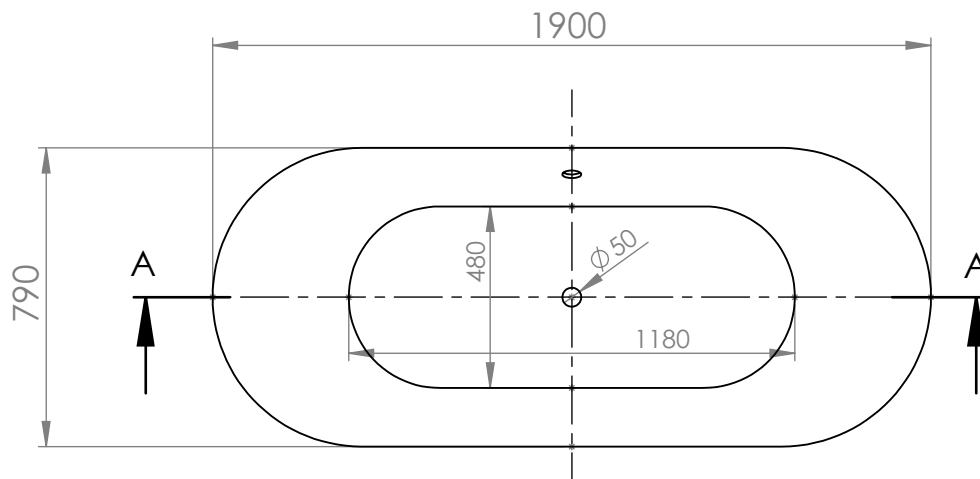
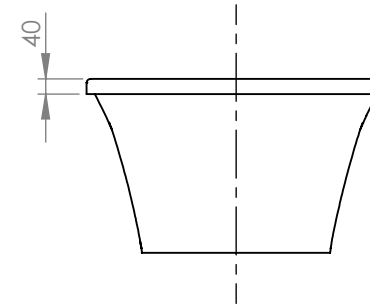

		TITLE:	
		BATHTUB OVAL 190X80	
DRAWN	DATE	NAME	DWG NO.
	13/05/2021	KONSTANTINOS PAIZANOS	A4
SCALE:1:20			SHEET 1 OF 1