

SECTION A-A

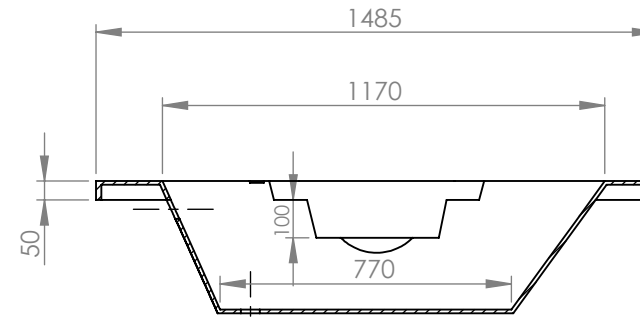

SECTION B-B

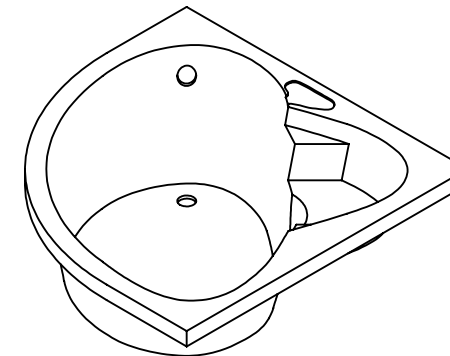
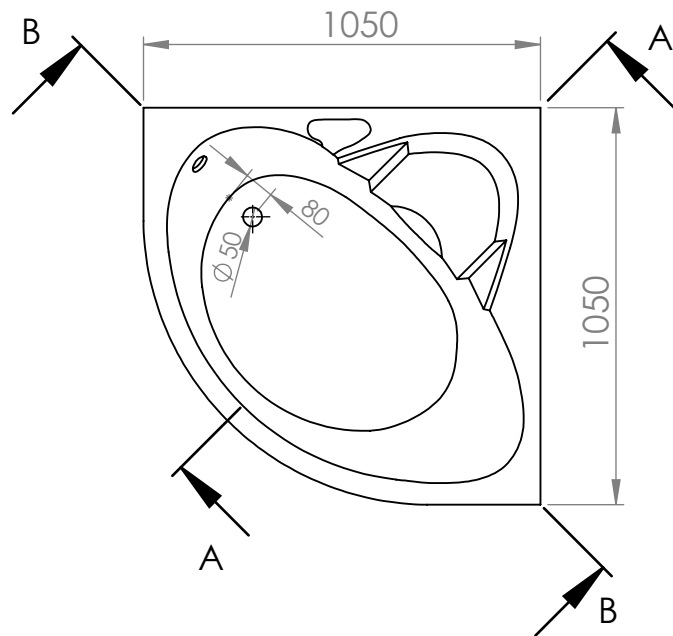

		TITLE:	
		BATHTUB MYKONOS 105X105	
DRAWN	DATE	NAME	DWG NO.
	22/11/2021	KONSTANTINOS PAIZANOS	A4
SCALE:1:20			SHEET 1 OF 1