

SECTION A-A

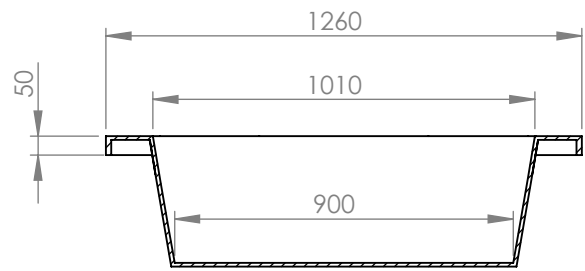

SECTION B-B

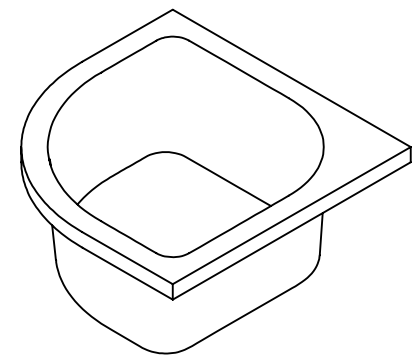
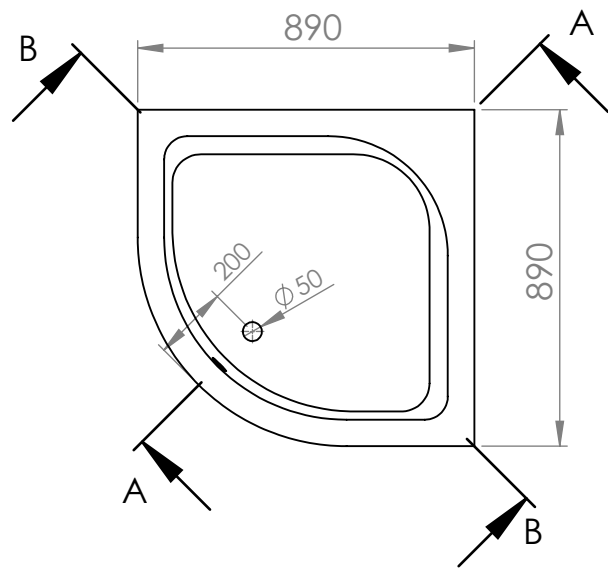

		TITLE:	
		BATHTUB MYKONOS 090X090	
DRAWN	DATE	NAME	DWG NO.
	20/05/2022	KONSTANTINOS PAIZANOS	A4
		SCALE:1:20	SHEET 1 OF 1