

SECTION A-A

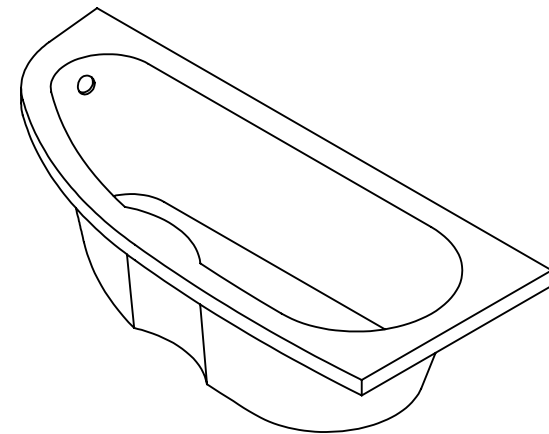

		TITLE:	
		BATHTUB KOCHILI RIGHT 170X70	
DRAWN	DATE	NAME	DWG NO.
	15/08/2022	KONSTANTINOS PAIZANOS	A4
		SCALE:1:20	SHEET 1 OF 1

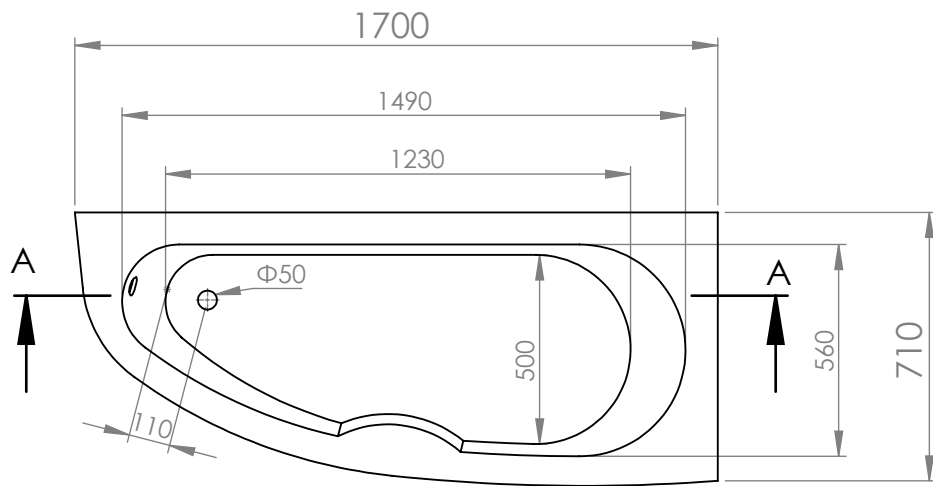
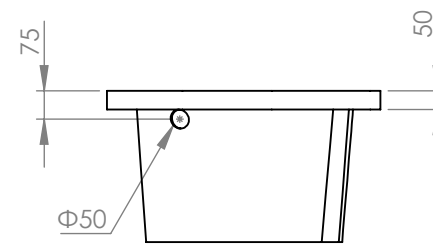
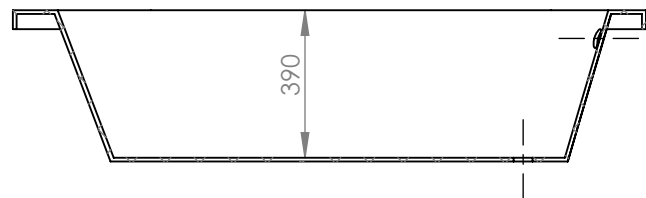
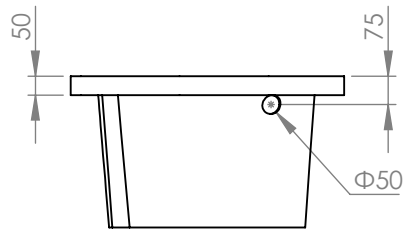

SECTION A-A

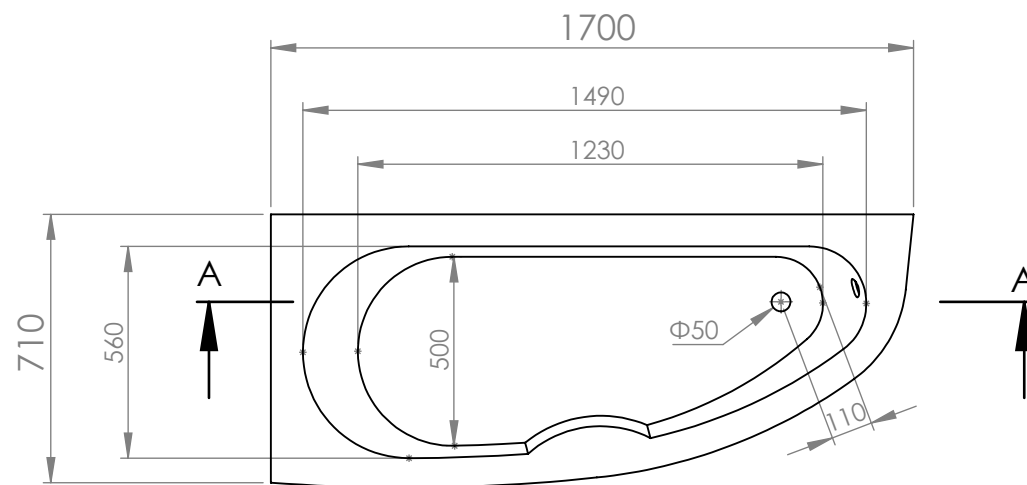
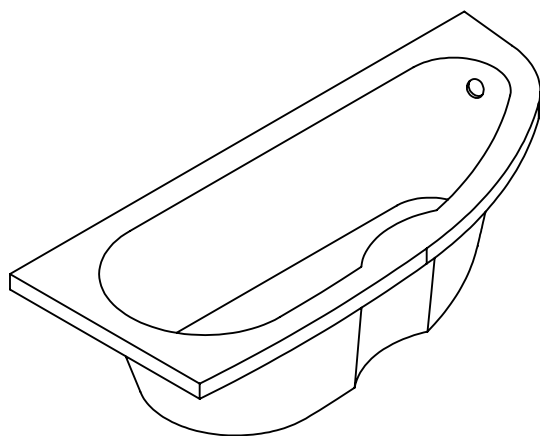

			TITLE:	
			BATHTUB KOCHILI LEFT 170X70	
DRAWN	DATE	NAME	DWG NO.	
	15/08/2022	KONSTANTINOS PAIZANOS	A4	
			SCALE:1:20	SHEET 1 OF 1